

THE WES COLLECTION
Soft yet striking.



**SWISS
DESIGN**
FURNITURE
MAKER



**THE WES COLLECTION:
ARMCHAIR, LOUNGE, CONVEX
LOUNGE, ANGLED ARM LOUNGE,
CHAISE & OTTOMAN**

The Wes lounge was named after its soft yet striking appearance, paying homage in name to film director Wes Anderson.

The collection is the result of a unique collaboration of work between the designer Tom Fereday and furniture maker Darren McKinnon. An exploration into the design refinement process itself, merging contemporary design systems with traditional upholstery techniques and craftsmanship.

Constructed entirely from sustainably sourced timber, GECA approved foams and water-based adhesives, finished with solid American Oak legs. Wes can be configured to create various forms that highlight seamless upholstery from every angle.





Complex yet minimal forms with entirely seamless upholstery from every angle.



Contrasting piping celebrates
the soft form of the lounge.



CONFIGURATIONS

The Wes collection includes lounges and ottomans in a variety of shapes, sizes and finishes offering an assortment of unique colour options and styles.

Wes 1370 & Wes 2000 lounges

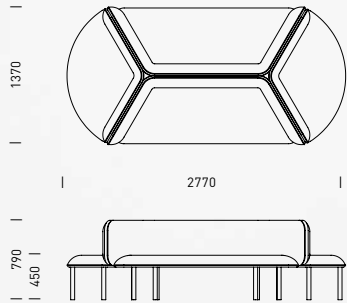



Wes 1370 lounges

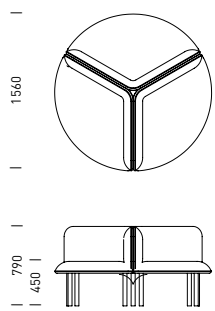

Wes 800 Armchair

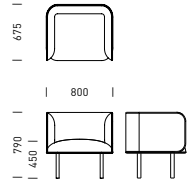

Wes 900 Armchair

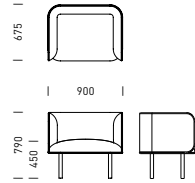

Wes 675 Ottoman



Wes 1350 Ottoman

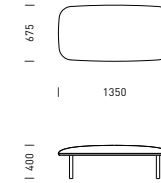

Wes 1800 Lounge

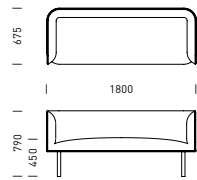

Wes 2000 Angled Arm Lounge

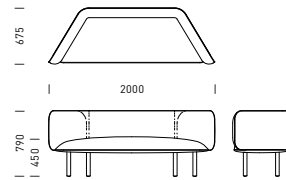

Wes 1270 Ottoman

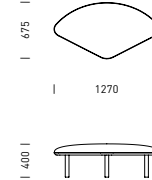

Wes 1835 Ottoman

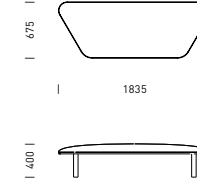

Wes 1370 Convex Lounge

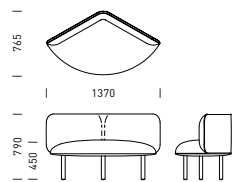

Wes 1800 Chaise Lounge LHS

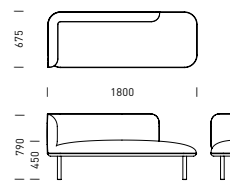

Wes 1800 Chaise Lounge RHS

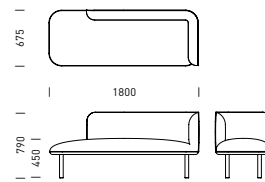

Wes 1835 Ottoman LHS

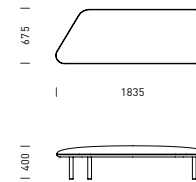

Wes 1835 Ottoman RHS

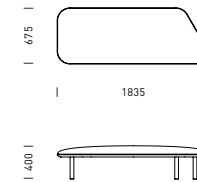

Wes 1800 Ottoman

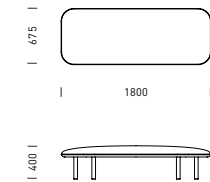

Wes Seat Sofa Configurations

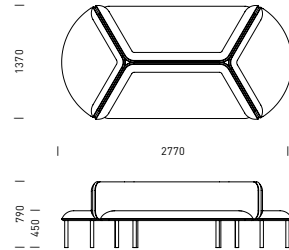
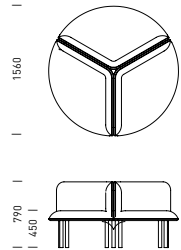

Wes Ottoman Configurations

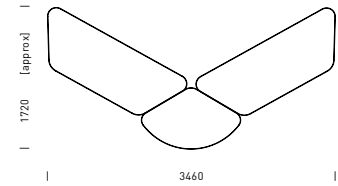
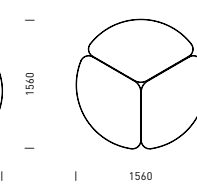
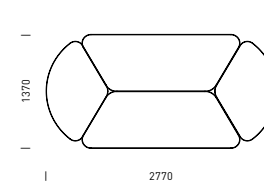

Wes 1800 lounge
Wes 1350 Ottoman



Wes 1350 & 675 Ottomans





FINISHES

Wes is available in a variety of sizes, finishes and offers a large range of unique colour with optional two tone upholstery.

Textile coverings: Fully upholstered in approved contract fabric, vinyl and leather

Piping: White or black house leather or matching or contrasting colours

Legs: Solid American Oak natural polished or black stained



ECO

All product manufactured from CFC free, GECA approved foams, water based adhesives and sustainably sourced FSC timbers.



Wes 1270 & 1835 Ottomans

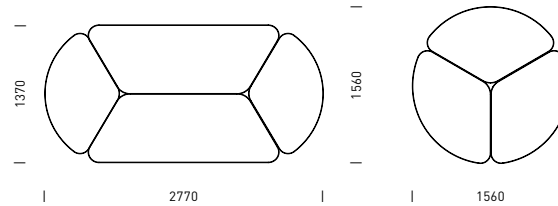

Wes 1800 lounge
Wes 675 Ottoman

WES – EXAMPLE CONFIGURATIONS

ISOMETRIC DRAWINGS ARE NOT TO SCALE

01 Wes 2000 Angled Lounge (2)
Wes 1370 Angled Lounge (2)

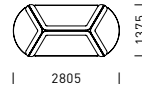
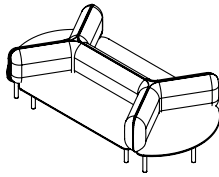

05 Wes 1835 Angled Ottoman (2)
Wes 1270 Angled Ottoman

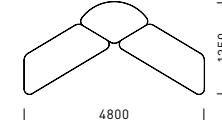
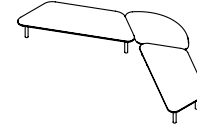

02 Wes 1835 Angled Ottoman (2)
Wes 1270 Angled Ottoman (2)

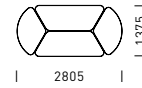
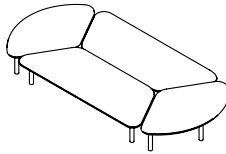

06 Wes 1800 Chaise Lounge Left (2)
Wes 1800 Chaise Lounge Right (2)

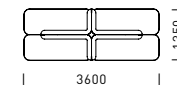
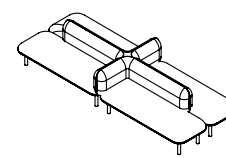

03 Wes 1370 Angled Lounge (3)

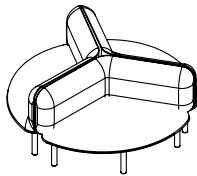

07 Wes 1800 Lounge (2)
Wes 900 Lounge (2)
Wes 1350 Ottoman (2)

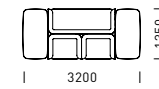
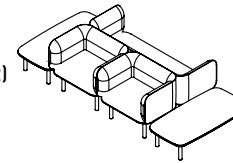

04 Wes 1270 Angled Ottoman (3)

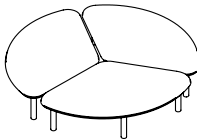

08 Wes 900 Lounge (6)
Wes 675 Ottoman (6)

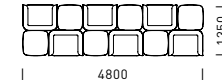
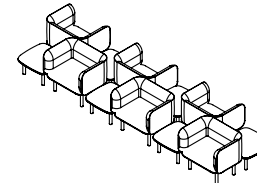

WES – EXAMPLE CONFIGURATIONS

ISOMETRIC DRAWINGS ARE NOT TO SCALE

09 Wes 2000 Angled Lounge (6)

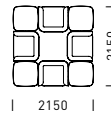
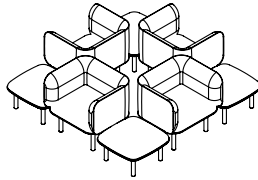

13 Wes 2000 Angled Lounge (4)
Wes 1370 Angled Lounge (2)

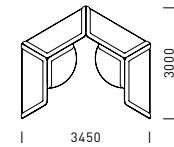
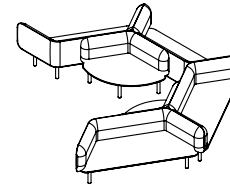

10 Wes 1800 Lounge (2)
Wes 900 Lounge (3)

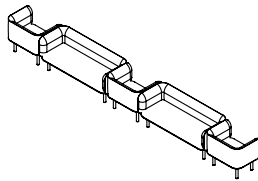

14 Wes 2000 Angled Lounge (2)
Wes 1270 Angled Ottoman (2)
Wes 1350 Ottoman

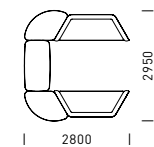
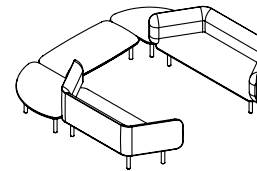

11 Wes 2000 Angled Lounge (6)

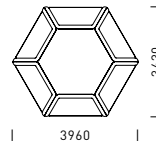
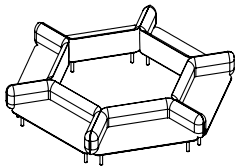

15 Wes 2000 Angled Lounge (5)
Wes 1370 Angled Lounge (4)

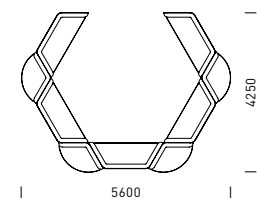
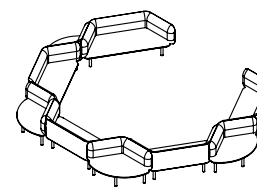

12 Wes 1370 Angled Lounge (5)

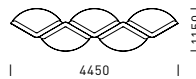
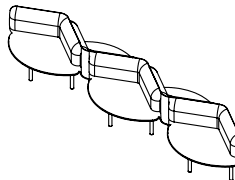

16 Wes 900 Lounge (16)
Wes 1350 Ottoman (3)

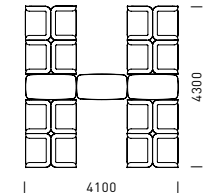
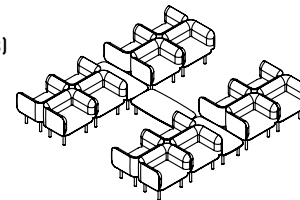

CARE & MAINTENANCE

FABRIC

- Upholstered products such as lounges should be protected from direct sunlight as this may lighten fabric colour
- Vacuum regularly on low suction
- Regularly rotate reversible cushions to allow even fading

LEATHER

- Upholstered products such as lounges should be protected from direct sunlight, direct heat and weather
- Regularly dust with a clean dry duster

POWDER COATED & CHROME STEEL

- Chair and table legs should be wiped down with a soft damp cloth
- Do not use abrasive cleaning products

LAMINATE

- Desks & tables should be cleaned with a soft, damp cloth
- Do not use abrasive cleaning products
- Wipe any liquid spills away quickly



**SWISS
DESIGN**
FURNITURE
MAKER
SINCE 1976