

SIRIUS SOFA SYSTEM WORKSHEET

ANTHONY GUERREE



Named after the brightest star in the night sky, Sirius is a contemporary and fully-upholstered modular sofa that provides a space for sharing, working or even a place where meals can be enjoyed. Right angles and curves combine for a flexible and asymmetrical interior landscape. A diverse selection of modules allows for numerous possible configurations.

DEFINING YOUR CONFIGURATION

You can create your desired configuration using one of the following methods:

COMMON CONFIGURATIONS

Find common configurations on pages 2-5. Each configuration can be ordered as drawn.

A LA CARTE

Define your own configuration using individual modules. Modules, procedures and graph paper can be found on pages 7-14.

COMMON DIMENSIONS

The sofa has a seat height of 41.5cm | 16 1/3" and backrest height of 65.5cm | 25 4/5"

SCATTER CUSHIONS

Scatter cushions are available in two sizes and are included in most pre-defined modules: Modules with backrest E or backrest ZL/ZR come with one medium scatter cushion (W50 × H50 cm | W19 3/4 × H19 3/4 "). Modules with any other back come with one medium (W50 × H50 cm | W19 3/4 × H19 3/4 ") and one small scatter cushion (W50 × H25 cm | W19 3/4 × H9 4/5 "). Ottomans and seats without backrests do not come with scatter cushions. Additional scatter cushions can be ordered separately. Specify these on the Finishing Touches page.

VELCRO CONNECTORS

Velcro connectors will be provided to fix the modules into the configuration ordered.

**COMMON CONFIGURATIONS**

**SIRIUS SOFA BY ANTHONY GUERREE**

Tick your chosen configuration. NOTE: The scatter cushions included in the drawings are included with the configuration.

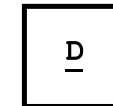

172 01 MEDIUM SOFA WITH ARMS  
(ZLJ + ZRJ)  
W212 × D91 × H65.5 cm  
W83 1/2 × D35 4/5 × H25 4/5 "

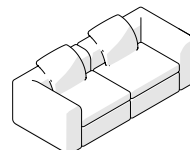
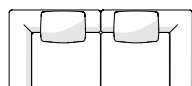

172 02 LONG SOFA WITH ARMS  
(ZLJ + EJ + ZRJ)  
W292 × D91 × H65.5 cm  
W115 × D35 4/5 × H25 4/5 "

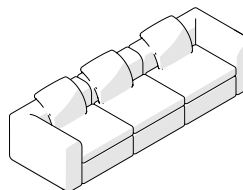
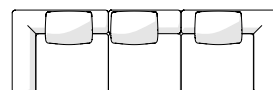

172 03R CORNER UNIT SOFA  
(ILM + ZRVL OR IRM + ZLVR)  
OR

172 03L CORNER UNIT SOFA  
(IRM + ZLVR)  
W252 × L166 × H65.5 cm  
W99 1/4 × L65 2/5 × H25 4/5 "

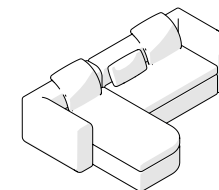
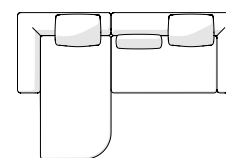
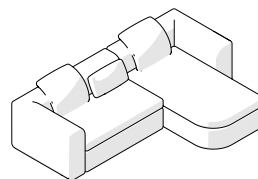
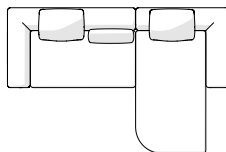

172 04R CORNER UNIT SOFA  
(FYL + J + ILYR)  
OR

172 04L CORNER UNIT SOFA  
(FYR + J + IRYL)  
W331 × L186 × H65.5 cm  
W130 1/3 × L73 1/4 × H25 4/5 "

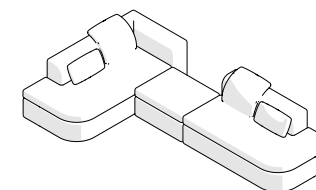
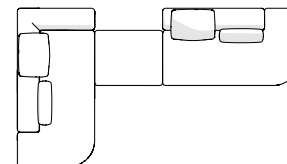
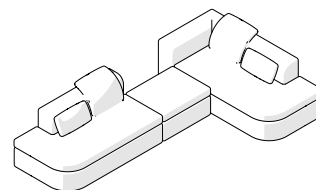
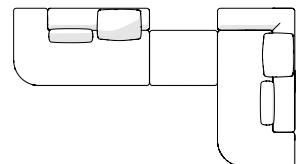

**COMMON CONFIGURATIONS**

SIRIUS SOFA BY ANTHONY GUERREE

Tick your chosen configuration. NOTE: The scatter cushions included in the drawings are included with the configuration.



172 05R CORNER UNIT SOFA  
(FYL + EJ + ILYR)

OR

172 05L CORNER UNIT SOFA  
(FYR + EJ + IRYL)

W331 × L186 × H65.5 cm

W130 1/3 × L73 1/4 × H25 4/5 "

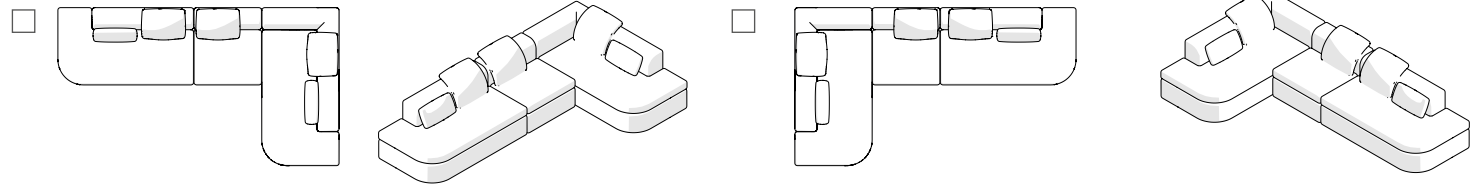

172 06L CORNER UNIT SOFA  
(ZRVR + FYL)

OR

172 06R CORNER UNIT SOFA  
(ZLVL + FYR)

W266 × L166 × H65.5 cm

W104 3/4 × L65 2/5 × H25 4/5 "

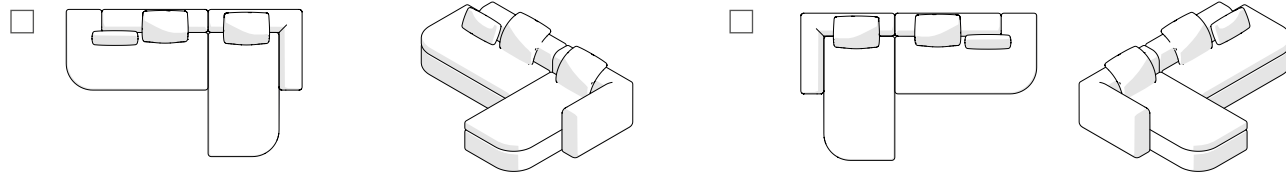

172 07R CORNER UNIT SOFA  
(GUL + ILTR)

OR

172 07L CORNER UNIT SOFA  
(GUR + IRTL)

W251 × L146 × H65.5cm

W98 4/5 × L57 1/2 × H25 4/5 "

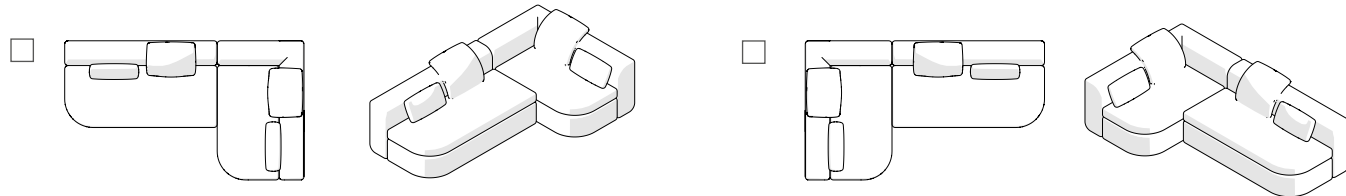

**COMMON CONFIGURATIONS**

**SIRIUS SOFA BY ANTHONY GUERREE**

Tick your chosen configuration. NOTE: The scatter cushions included in the drawings are included with the configuration.



172 08 ISLAND SOFA  
(GUL + EJ + FYL)  
W240 x D182 x H65.5cm  
W94 1/2 x L71 3/4 x H25 4/5 "

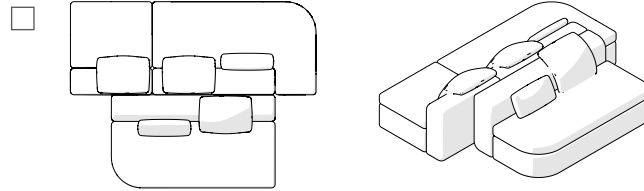

172 09 ISLAND SOFA  
(GUR + EQL + J + P)  
W240 x D205 x H65.5cm  
W94 1/2 x D80 3/4 x H25 4/5 "

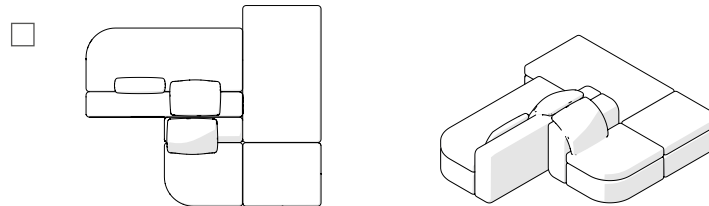

172 10 LINEAR SOFA WITH CENTRAL  
OTTOMAN  
(EQL + O + FYR)  
W320 x D91 x H65.5 cm  
W126 x D35 4/5 x H25 4/5 "

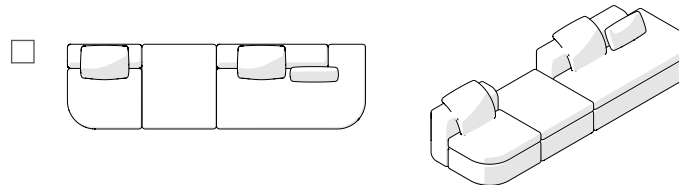

COMMON CONFIGURATIONS

SIRIUS SOFA BY ANTHONY GUERREE

Tick your chosen configuration. NOTE: The scatter cushions included in the drawings are included with the configuration.

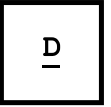

172 O OTTOMAN  
W80 × D91 × H41.5 cm  
W31 1/2 × D35 4/5 × H16 1/3 "



---

172 SL OTTOMAN WITH ROUNDED EDGE -  
LEFT  
172 SR OTTOMAN WITH ROUNDED EDGE -  
RIGHT  
W80 × D91 × H41.5 cm  
W31 1/2 × D35 4/5 × H16 1/3 "

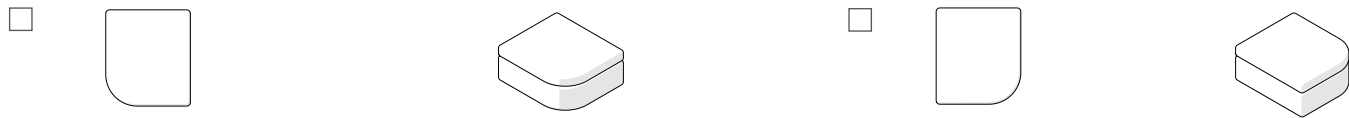

**FINISHING TOUCHES**

SIRIUS SOFA BY ANTHONY GUERREE

If you wish to order scatter cushions additional to those included with your chosen configuration, please specify this below, along with your chosen upholstery then sign to confirm your configuration and selections.



SCATTER CUSHIONS

QUANTITY

172MU MEDIUM SCATTER  
CUSHION  
W50 × H50 cm  
W19 3/4 × H19 3/4 "



---

172SU SMALL SCATTER CUSHION  
W50 × H25 cm  
W19 3/4 × H9 4/5 "



---

UPHOLSTERY

PLEASE SPECIFY

---

DATE:

ORDER ID:

CLIENT NAME:

By signing below, the client confirms the configuration and materials of the unit ordered.

\_\_\_\_\_  
Client signature

\_\_\_\_\_  
Date

\_\_\_\_\_  
Sales Associate signature

\_\_\_\_\_  
Date

**CREATE YOUR OWN CONFIGURATION**  
**SIRIUS SOFA BY ANTHONY GUERREE**



Below is a list of modules organised by seat. Select your preferred modules from pages 7-11 then use the space on pages 12-13 to draw your chosen configuration, before completing page 14. Seat height is 41.5cm | 16 1/3". Backrest height is 65.5cm | 25 4/5".  
 NOTE 1: Modules cannot be attached to the following: curved edges of seats, or the overhanging portion of a backrest where longer than the seat to which it is attached.

**MODULES**

**SEAT J**

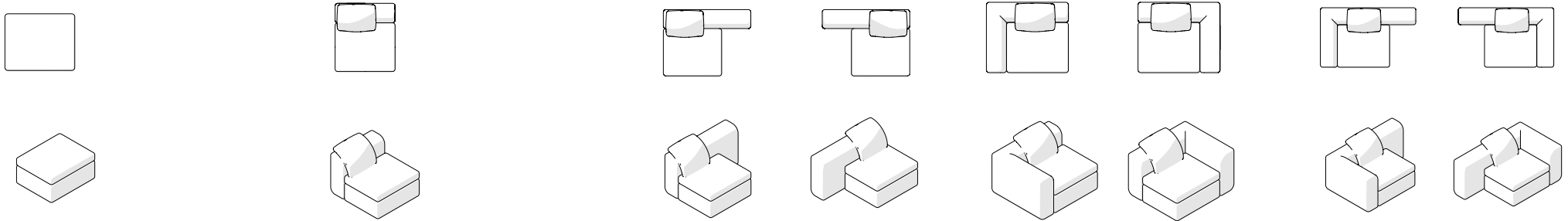

172J	172EJ	172FJL	172FJR	172ZLJ	172ZRJ	172ILJ	172IRJ
SEAT J W80 × D65 cm W31 1/2" × D25 2/3 "	SEAT J + BACK E W80 × D91 cm W31 1/2 × D35 4/5 "	SEAT J + BACK F L/R W120 × D91 cm W47 1/4 × D35 4/5 "		SEAT J + BACK ZL/ZR W106 × D91 cm W41 3/4 × D35 4/5 "		SEAT J + BACK IL/IR W146 × D91 cm W57 1/2 × D35 4/5 "	

**SEAT P**

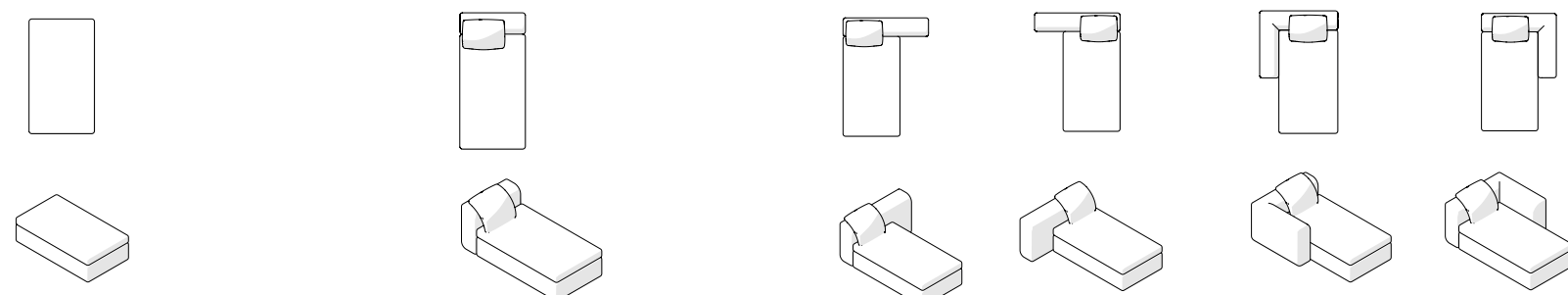

172P	172EP	172FPL	172FPR	172ZLP	172ZRP
SEAT P W80 × L140 cm W31 1/2 × L55 1/8 "	SEAT P + BACK E W80 × L166 cm W31 1/2 × L65 2/5 "	SEAT P + BACK F L/R W120 × L166 cm W47 1/4 × L65 2/5 "		SEAT P + BACK ZL/ZR W106 × L166 cm W41 3/4 × L65 2/5 "	

**CREATE YOUR OWN CONFIGURATION**

**SIRIUS SOFA BY ANTHONY GUERREE**

Below is a list of modules organised by seat. Select your preferred modules from pages 7-11 then use the space on pages 12-13 to draw your chosen configuration, before completing page 14. Seat height is 41.5cm | 16 1/3". Backrest height is 65.5cm | 25 4/5".  
 NOTE 1: Modules cannot be attached to the following: curved edges of seats, or the overhanging portion of a backrest where longer than the seat to which it is attached.



**MODULES**

**SEAT M**

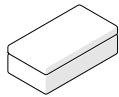

172M

SEAT M  
 W120 × L65 cm  
 W47 1/4 × L25 2/3 "

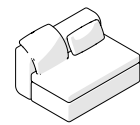
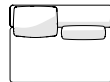

172FM

SEAT M + BACK F  
 W120 × D91 cm  
 W47 1/4 × D35 4/5 "

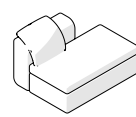
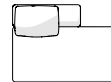

172EML

SEAT M + BACK E L/R  
 W120 × D91 cm  
 W47 1/4 × D35 4/5 "

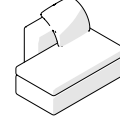
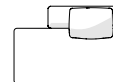

172EMR

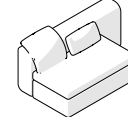
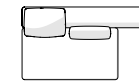

172GML

SEAT M + BACK G L/R  
 W160 × D91 cm  
 W63 × D35 4/5 "

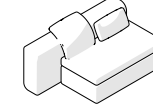
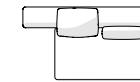

172GMR

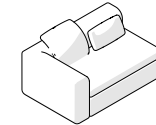
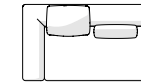

172ILM

SEAT M + BACK IL/IR  
 W146 × D91 cm  
 W57 1/2 × D35 4/5 "

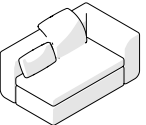
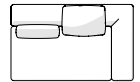

172IRM

**SEAT QL/QR**

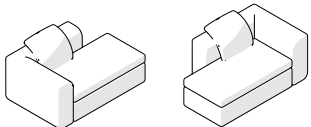

172ZLM 172ZRM

SEAT M + BACK ZL/ZR  
 W146 × D91 cm  
 W57 1/2 × D35 4/5 "



172QL 172QR

SEAT QL/QR  
 W80 × L65 cm  
 W31 1/2 × L25 2/3 "

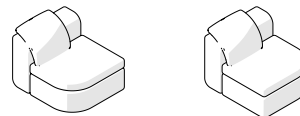

172EQL 172EQR

SEAT QL/QR + BACK E  
 W80 × D91 cm  
 W31 1/2 × D35 4/5 "

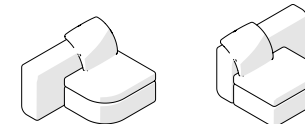
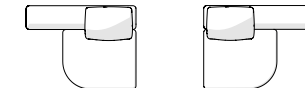

172FQL 172FQR

SEAT QL/QR + BACK F  
 W120 × D91 cm  
 W47 1/4 × D35 4/5 "



**CREATE YOUR OWN CONFIGURATION**  
**SIRIUS SOFA BY ANTHONY GUERREE**



Below is a list of modules organised by seat. Select your preferred modules from pages 7-11 then use the space on pages 12-13 to draw your chosen configuration, before completing page 14. Seat height is 41.5cm | 16 1/3". Backrest height is 65.5cm | 25 4/5".  
 NOTE 1: Modules cannot be attached to the following: curved edges of seats, or the overhanging portion of a backrest where longer than the seat to which it is attached.

**MODULES**

**SEAT TL/TR**

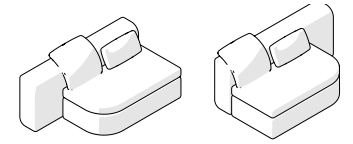
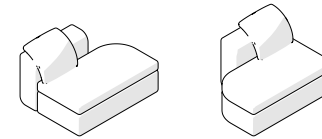
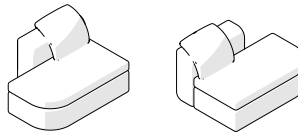
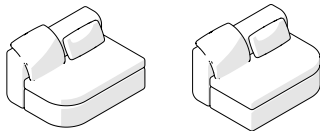
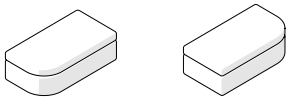
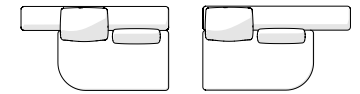
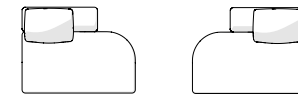
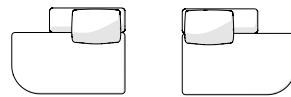
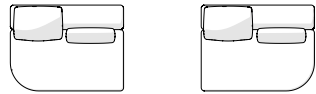
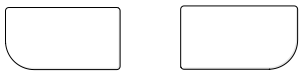

172TL

172TR

172FTL

172FTR

172ETL

172ETR

172ETLI

172ETRI

172GTL

172GTR

SEAT TL/TR

W120 × L65 cm

W47 1/4 × L25 2/3 "

SEAT TL/TR + BACK F

W120 × D91 cm

W47 1/4 × D35 4/5 "

SEAT TL/TR + BACK E

W120 × D91 cm

W47 1/4 × D35 4/5 "

SEAT TL/TR + BACK E

I (INVERSE)

W120 × D91 cm

W47 1/4 × D35 4/5 "

SEAT TL/TR + BACK G

W160 × D91 cm

W63 × D35 4/5 "

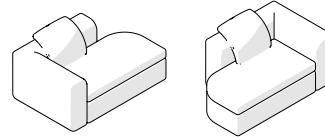
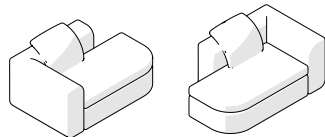
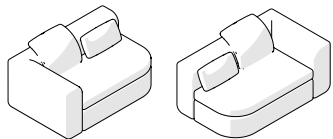
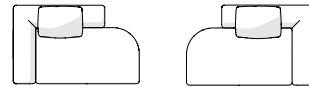
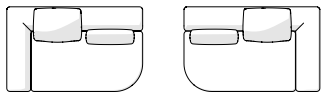

172ILTR

172IRTL

172ZLTR

172ZRTL

172ZLTLI

172ZRTRI

SEAT TL/TR + BACK IL/IR

W146 × D91 cm

W57 1/2 × D35 4/5 "

SEAT TL/TR + BACK ZL/ZR

W146 × D91 cm

W57 1/2 × D35 4/5 "

SEAT TL/TR + BACK ZL/ZR

I (INVERSE)

W146 × D91 cm

W57 1/2 × D35 4/5 "

**CREATE YOUR OWN CONFIGURATION**

**SIRIUS SOFA BY ANTHONY GUERREE**

Below is a list of modules organised by seat. Select your preferred modules from pages 7-11 then use the space on pages 12-13 to draw your chosen configuration, before completing page 14. Seat height is 41.5cm | 16 1/3". Backrest height is 65.5cm | 25 4/5".  
NOTE 1: Modules cannot be attached to the following: curved edges of seats, or the overhanging portion of a backrest where longer than the seat to which it is attached.

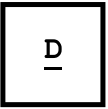

**MODULES**

**SEAT UL/UR**

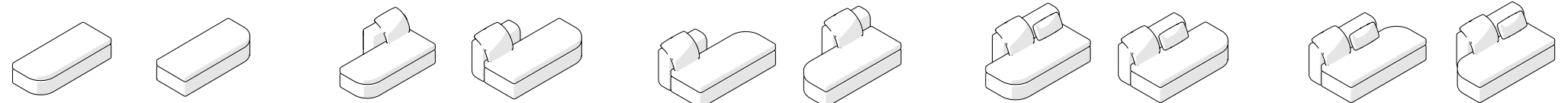
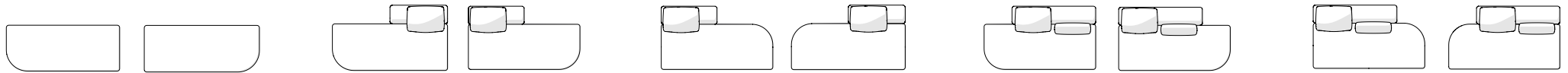

172UL      172UR      172EUL      172EUR      172EULI      172EURI      172FUL      172FUR      172FULI      172FURI

SEAT UL/UR  
W160 × L65 cm  
W63 × L25 2/3 "

SEAT UL/UR + BACK E  
W160 × D91 cm  
W63 × D35 4/5 "

SEAT UL/UR + BACK E  
I (INVERSE)  
W160 × D91 cm  
W63 × D35 4/5 "

SEAT UL/UR + BACK F  
W160 × D91 cm  
W63 × D35 4/5 "

SEAT UL/UR + BACK F  
I (INVERSE)  
W160 × D91 cm  
W63 × D35 4/5 "

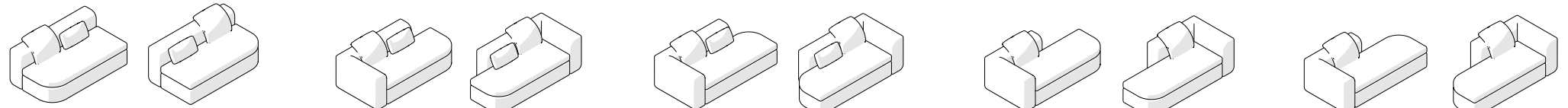
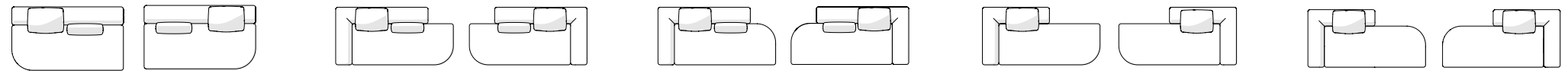

172GUL      172GUR      172ILUR      172IRUL      172ILULI      172IRURI      172ZLUR      172ZRUL      172ZLULI      172ZRURI

SEAT UL/UR + BACK G  
W160 × D91 cm  
W63 × D35 4/5 "

SEAT UL/UR + BACK IL/IR  
W186 × D91 cm  
W73 1/4 × D35 4/5 "

SEAT UL/UR + BACK IL/IR  
I (INVERSE)  
W186 × D91 cm  
W73 1/4 × D35 4/5 "

SEAT UL/UR + BACK ZL/ZR  
W186 × D91 cm  
W73 1/4 × D35 4/5 "

SEAT UL/UR + BACK ZL/ZR  
(INVERSE)  
W186 × D91 cm  
W73 1/4 × D35 4/5 "

**CREATE YOUR OWN CONFIGURATION**

**SIRIUS SOFA BY ANTHONY GUERREE**

Below is a list of modules organised by seat. Select your preferred modules from pages 7-11 then use the space on pages 12-13 to draw your chosen configuration, before completing page 14. Seat height is 41.5cm | 16 1/3". Backrest height is 65.5cm | 25 4/5".

NOTE 1: Modules cannot be attached to the following: curved edges of seats, or the overhanging portion of a backrest where longer than the seat to which it is attached.

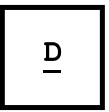

**MODULES**

**SEAT VL/VR**

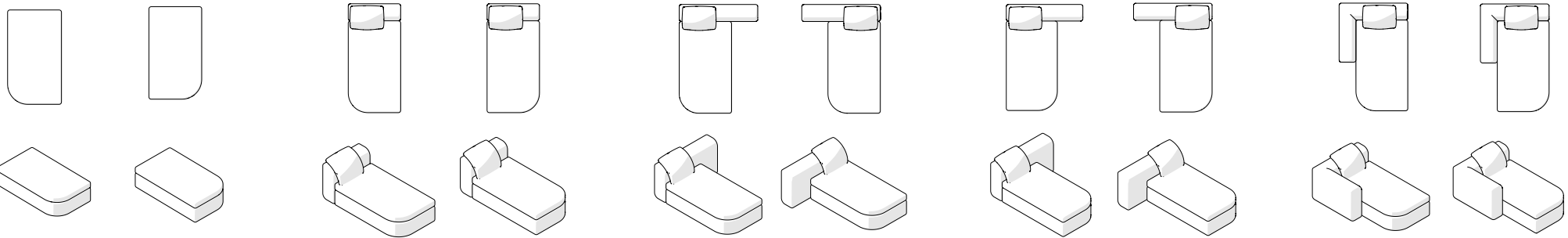

172VL      172VR      172EVL      172EVR      172FVLL      172FVLR      172FVRL      172FVRR      172ZLVL      172ZLVR

SEAT VL/VR  
W80 × L140 cm  
W31 1/2 × L55 1/8 "

SEAT VL/VR + BACK E  
W80 × L166 cm  
W31 1/2 × L65 2/5 "

SEAT VL/VR + BACK F  
W120 × L166 cm  
W47 1/4 × L65 2/5 "

SEAT VL/VR + BACK F  
W120 × L166 cm  
W47 1/4 × L65 2/5 "

SEAT VL/VR + BACK ZL  
W106 × L166 cm  
W41 3/4 × L65 2/5 "

**SEAT YL/YR**

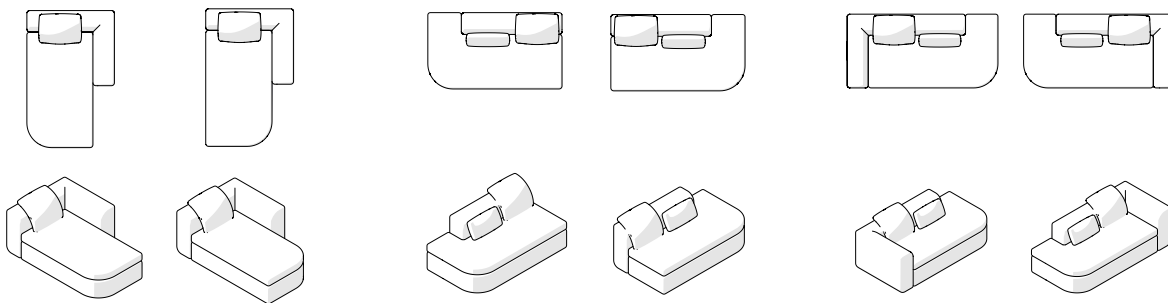

172ZRVL      172ZRVR      172FYL      172FYR      172ILYR      172IRYL

SEAT VL/VR + BACK ZR  
W106 × L166 cm  
W41 3/4 × L65 2/5 "

SEAT YL/YR + BACK F  
W160 × D91 cm  
W63 × D35 4/5 "

SEAT YL/YR + BACK IL/IR  
W186 × D91 cm  
W73 1/4 × D35 4/5 "

**OTTOMAN O**

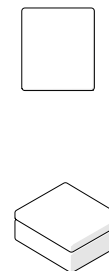

172O

OTTOMAN O  
W80 × D91 cm  
W31 1/2 × D35 4/5 "

**OTTOMAN SL/SR**

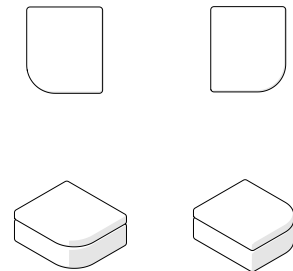

172SL      172SR

OTTOMAN SL/SR  
W80 × D91 cm  
W31 1/2 × D35 4/5 "

**CREATE YOUR OWN CONFIGURATION**

SIRIUS SOFA BY ANTHONY GUERREE

**DRAW YOUR CHOSEN CONFIGURATION**

Choosing from the modules detailed on pages 7-11, create your configuration and draw it in the space below. NOTE: Modules cannot be attached to the following: curved edges of seats, or the overhanging portion of a backrest where the backrest is longer than the seat to which it is attached.

EXAMPLE DRAWING

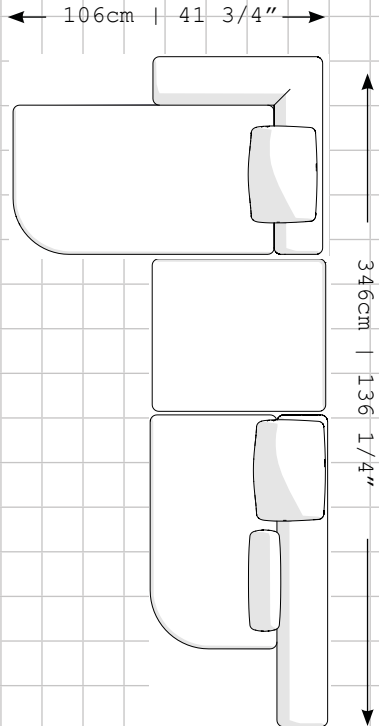

This example sofa consists of:

1x 172ZLVL  
(1 scatter cushion included, measuring W50  
x H50 cm | W19 3/4 x H19 3/4 ")

1x 1720

1x 172GTR  
(2x scatter cushions included, one measur-  
ing W50 x H50 cm | W19 3/4 x H19 3/4 " and  
one measuring W50 x H25 cm | W19 3/4 x H9  
4/5 ")

COMMON DIMENSIONS

All modules have the following dimensions:  
Seat height 41.5cm | 16 1/3"

All modules with backrests have the following  
dimensions:  
Backrest height 65.5cm | 25 4/5"

CREATE YOUR OWN CONFIGURATION

SIRIUS SOFA BY ANTHONY GUERREE

DRAW YOUR CHOSEN CONFIGURATION



Choosing from the modules detailed on pages 7-11, create your configuration and draw it in the space below. NOTE: Modules cannot be attached to the following: curved edges of seats, or the overhanging portion of a backrest where the backrest is longer than the seat to which it is attached.

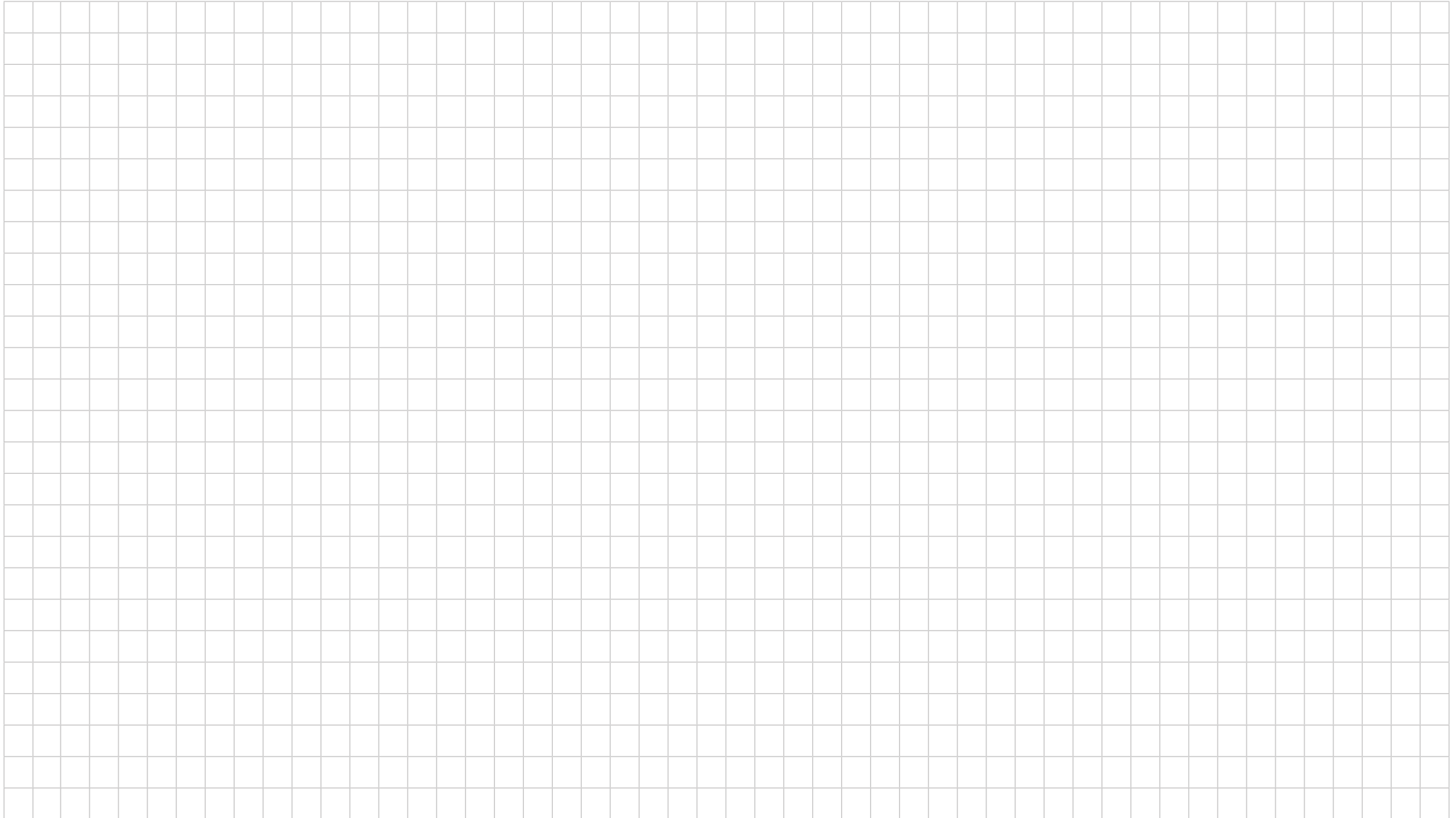

**FINISHING TOUCHES**

SIRIUS SOFA BY ANTHONY GUERREE

If you wish to order scatter cushions additional to those included with your chosen modules, please specify this below, along with your chosen upholstery then sign to confirm your selection.



SCATTER CUSHIONS

QUANTITY

172MU MEDIUM SCATTER  
CUSHION  
W50 × H50 cm  
W19 3/4 × H19 3/4 "



\_\_\_\_\_

172SU SMALL SCATTER CUSHION  
W50 × H25 cm  
W19 3/4 × H9 4/5 "



\_\_\_\_\_

UPHOLSTERY

PLEASE SPECIFY

\_\_\_\_\_

DATE:

ORDER ID:

CLIENT NAME:

By signing below, the client confirms the configuration and materials of the unit ordered.

\_\_\_\_\_  
Client signature

\_\_\_\_\_  
Date

\_\_\_\_\_  
Sales Associate signature

\_\_\_\_\_  
Date